

**MO&MA**  
COLLECTION  
**2021**



CREATE  
YOUR  
HOME

MADE IN ITALY

A  
M  
&  
O  
M

# MO&MA

Design by Eros Angelini

## Nuova linea MO&MA: eleganza e funzionalità.

Design e tecnologia si fondono armonicamente nella nuova linea Munari, come in un'opera d'arte moderna. L'unione tra design e materiali innovativi stabilisce standard di raffinatezza ancora più elevati. Fedeli al motto "Create your home", vetro, legno, ceramica e metallo creano con le loro molteplici combinazioni un mobile esclusivo e personalizzato per la zona giorno.

## New MO&MA collection: elegance and functionality.

Design and technology harmoniously come together in the new collection by Munari, like a work of modern art. The combination of design and innovative materials sets even higher standards of refinement. True to the motto "Create your home", glass, wood, ceramic and metal, in a multitude of combinations, create an exclusive customised furniture unit for living spaces.

## Nouvelle ligne MO&MA: élégance et fonctionnalité.

Design et technologie se marient harmonieusement dans la nouvelle ligne Munari, comme dans une œuvre-d'art moderne. L'union entre design et matériaux novateurs établit un standard de raffinement encore plus élevé. Fidèles à la devise "Create your home", le verre, le bois, la céramique et le métal créent, en de multiples combinaisons, un meuble exclusif et personnalisé pour le séjour.

## Elegant Funktional.

Design und Technik verschmelzen bei dem Programm MO&MA und bilden eine Harmonie, wie bei einem modernen Kunstwerk. Die neue Formsprache setzt, in Kombination mit verschiedenen Materialinnovationen, neue Maßstäbe für den anspruchsvollen Wohnbereich. Hierbei werden Eleganz und Funktionalität in gleichem Maße ohne Kompromisse umgesetzt. Ganz nach dem Motto "Create YourHome" können die verschiedenen Werkstoffe in mehreren Ausführungen (Glas / Holz / Keramik / Metall) individuell kombiniert und so das besondere und smarte Möbelstück kreiert.





MO&MA GROUND AND WALL STYLE



GROUNDSTYLE



GROUNDSTYLE - SOUND

MO&MA LIFESTYLE

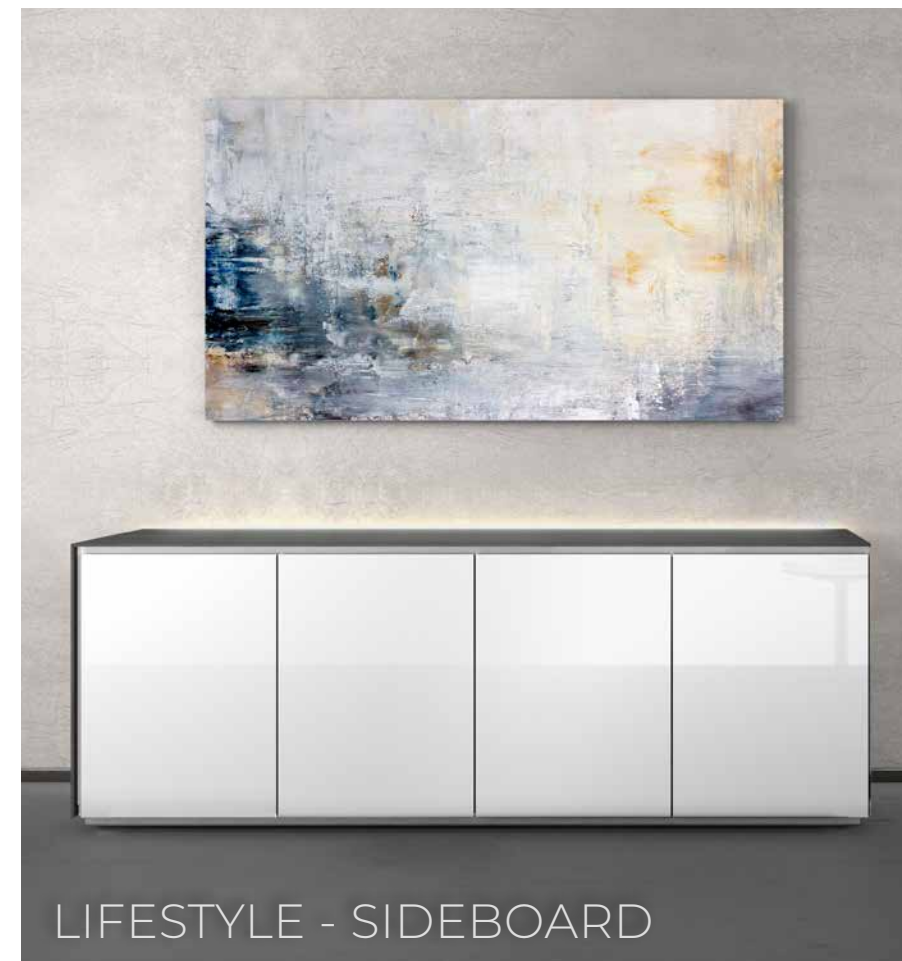

LIFESTYLE - SIDEBOARD



LIFESTYLE - FEET



GROUNDSTYLE - FEET



WALLSTYLE



LIFESTYLE - WALL SIDEBOARD



LIFESTYLE COFFEE TABLE

Finiture in legno e ceramica  
 Wood and ceramic finishes / Finitions en bois et céramique  
 Ausführungen - Holz und Keramik



**Placcato rovere naturale**  
 Natural oak veneer  
 Placage chêne naturel  
 Asteiche furniert

**Placcato rovere grigio**  
 Grey oak veneer  
 Placage chêne gris  
 Eiche grau furniert

**Placcato rovere antracite**  
 Anthracite oak veneer  
 Placage chêne anthracite  
 Eiche anthrazit furniert

**Placcato noce scuro**  
 Dark walnut veneer  
 Placage noyer foncé  
 Nussbaum furniert



**Ceramica effetto cemento**  
 Ceramic cement effect  
 Céramique effet béton  
 Keramik - (Optik: Zement)

**Ceramica effetto pietra antracite**  
 Ceramic anthracite stone effect  
 Céramique effet pierre anthracite  
 Keramik (Effekt-Stein anthrazit)

Finiture in vetro temperato  
 Tempered glass finishes / Finitions en verre trempé  
 Ausführungen - Temperiertes Glas

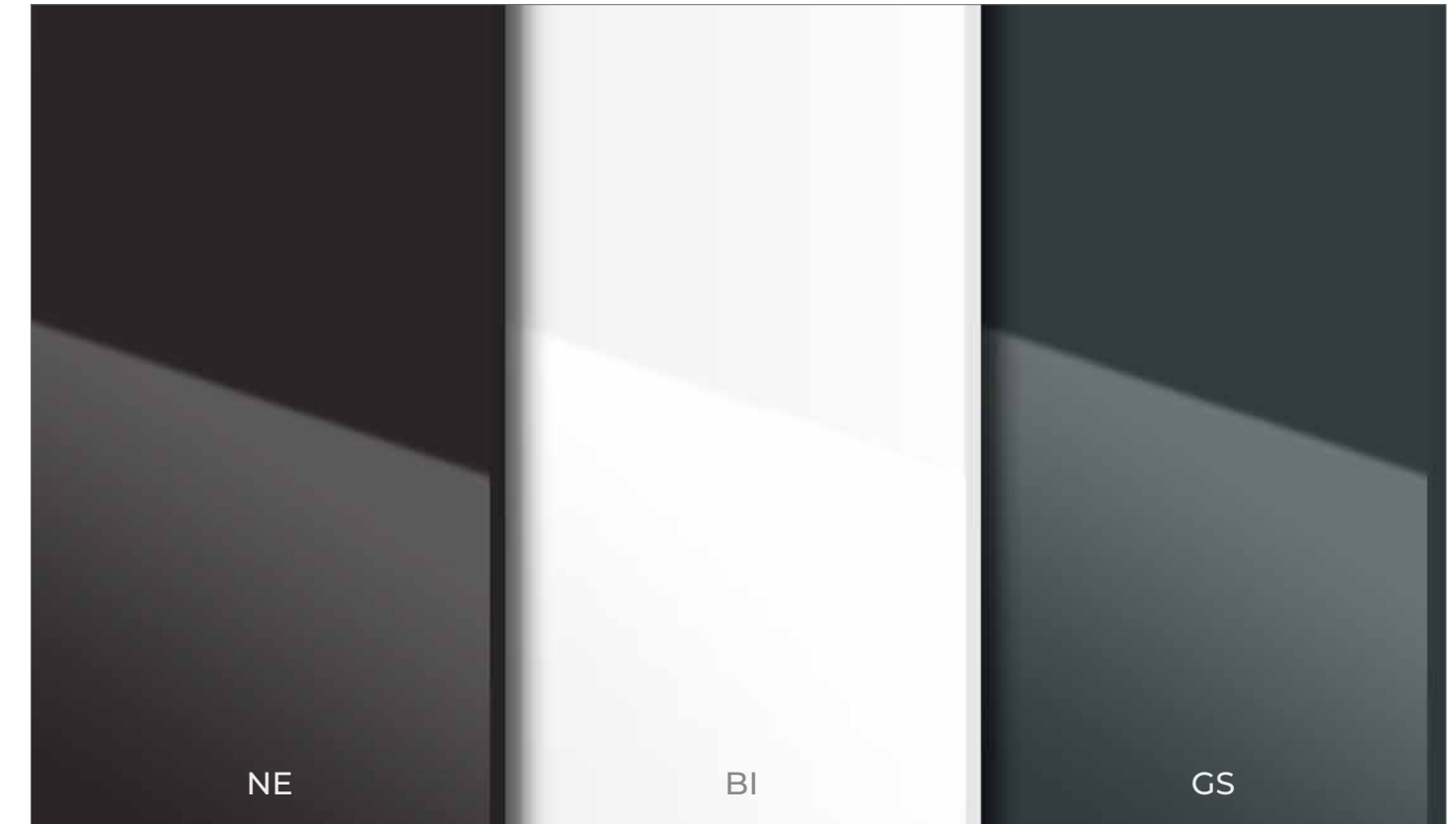

**Vetro nero lucido**  
 Shiny black glass  
 Verre noir brillant  
 Glas schwarz glänzend

**Vetro bianco lucido**  
 Shiny white glass  
 Verre blanc brillant  
 Glas weiß glänzend

**Vetro grigio scuro lucido**  
 Shiny dark grey glass  
 Verre gris foncé brillant  
 Glas dunkelgrau glänzend

Finiture per Design line  
 Design line finishes / Finitions pour Design line  
 Ausführungen - Design-Line



**DESIGN LINE rame spazzolato**  
 DESIGN LINE: brushed copper  
 DESIGN LINE cuivre brossé  
 Design-Line Kupfer gebürstet

**DESIGN LINE acciaio spazzolato**  
 DESIGN LINE: brushed steel  
 DESIGN LINE acier brossé  
 Design-Line Stahl gebürstet

**DESIGN LINE nero opaco**  
 DESIGN LINE: matt black  
 DESIGN LINE noir mat  
 Design-Line schwarz matt

# MO&MA FINISHING LAYOUT

81 combinazioni di finiture / 81 finishing combinations / 81 combinaisons de finitions / 81 Farb- und Materialkombinationen

COME ORDINARE IL MOBILE / HOW TO ORDER FURNITURE  
COMMENT COMMANDER LE MEUBLE / Bestellablauf zur Konfiguration des Möbels

**1**  
Scegliere l'articolo  
Choose the article  
Choisissez l'article  
Produkt-Auswahl

**2**  
Scegliere la dimensione  
Choose the length  
Choisissez les dimensions  
Artikel-Breitenübersicht

**3**  
Scegliere la finitura  
FRONTAL in vetro  
Choose FRONTAL  
glass finishes  
Choisissez la finition  
FRONTAL en verre  
Front- und Seitendarstellung

**4**  
Scegliere la finitura TOP  
Choose TOP finishes  
Choisissez la finition TOP  
Abdeckplatten- und  
Seitendarstellung

**5**  
Scegliere la finitura della  
DESIGN LINE e della base  
Choose DESIGN LINE  
and socle finishes  
Choisissez la finition du  
design line et de la base  
Design-Line-Darstellung

**OPTIONAL**  
Piedini opzionali  
Optional feet  
Pieds optionnels  
Kufenfuß

GROUND H.42	L. 125 / 150 / 175 / 200				
GROUND H.51	L. 125 / 150 / 175 / 200				
SOUND H.51	L. 175 / 200				
WALL	L. 150 / 175 / 200				
SIDEBOARD	L. 220				
WALL SIDEBOARD	L. 200				
COFFEE TABLE	L. 81 / 122				

**Audio Sound-System ACS 120 W**

Esempio di codice / Example code / Exemple de code / Code-Beispiel

MMB	176	L / R	BI	CCE	LNO
Collezione MO&MA MO&MA collection Collection MO&MA Bestell-Nr. MO&MA	Codice Articolo Article item Code d'article Artikel-Code	Mobile sinistro o destro Left or right furniture Meubles gauche ou droit Linke oder rechte Designausführung	FRONTAL DE: Glasausführung für Front und li. oder re. Seite	TOP DE: Materialausführung für Abdeckplatte und li. oder re. Seite	Design line, base e piedini opzionali Design line, socle & optional feet Desing line, base et pieds optionnels Materialausführung für Design-Line und Sockelumrandung (Kufenfuß optional)

B= base / base / base / bodenstehendes Grundelement  
W= sospeso al muro on the wall / suspendu au mur / wandhängendes Hängeelement  
S= madia / sideboard / buffet / Sideboard  
T= tavolino / coffee table / table basse / Couchtisch

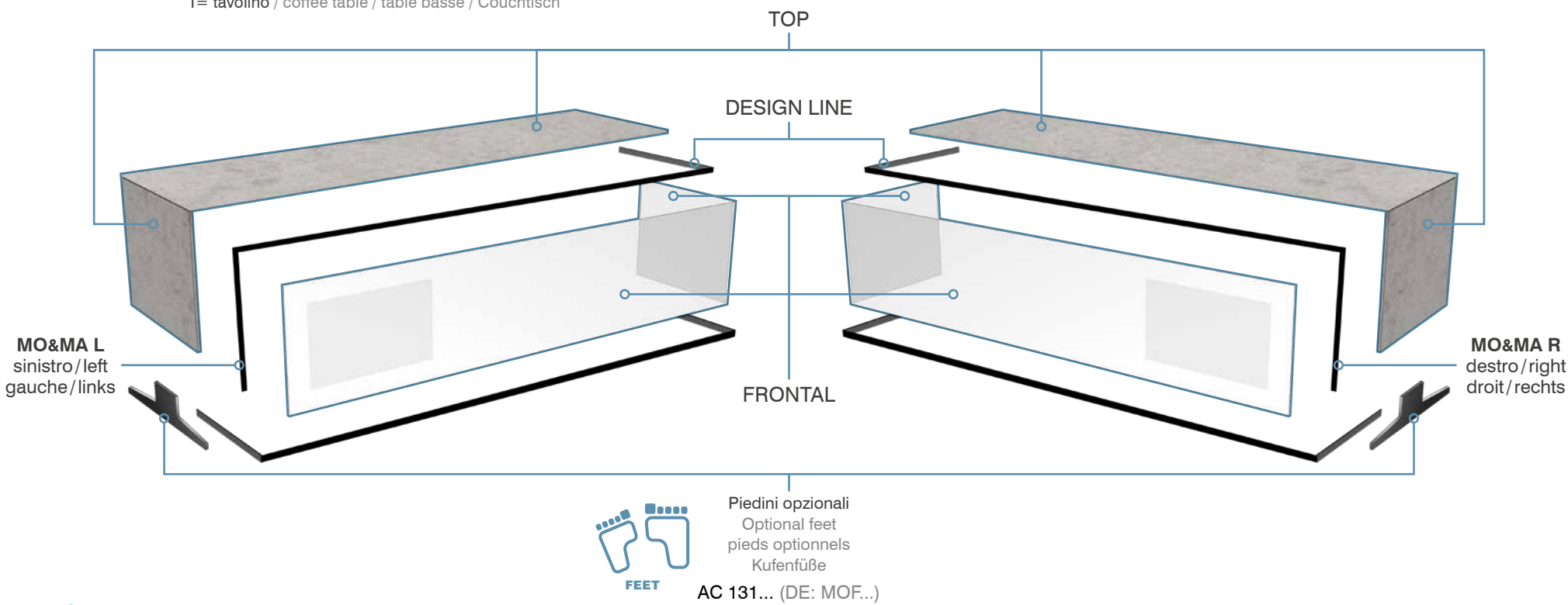

## VETRO / GLASS / VERRE / GLAS

Finiture per FRONTAL  
FRONTAL finishes  
Finitions pour FRONTAL  
Glasausführung für Front  
und li. oder re. Seite

 NE Vetro nero lucido Shiny black glass Verre noir brillant Glas schwarz glänzend	 BI Vetro bianco lucido Shiny white glass Verre blanc brillant Glas weiß glänzend	 GS Vetro grigio scuro lucido Shiny dark grey glass Verre gris foncé brillant Glas dunkelgrau glänzend
--	--	---

## VETRO / GLASS / VERRE / GLAS

Finiture per TOP  
TOP finishes  
Finitions pour TOP  
Materialausführung für Abdeckplatte  
und li. oder re. Seite

 NE Vetro nero lucido Shiny black glass Verre noir brillant Glas schwarz glänzend	 BI Vetro bianco lucido Shiny white glass Verre blanc brillant Glas weiß glänzend	 GS Vetro grigio scuro lucido Shiny dark grey glass Verre gris foncé brillant Glas dunkelgrau glänzend
--	--	---

## LEGNO / WOOD / BOIS / HOLZ

 RN Placcato rovere naturale Natural oak veneer Placage chêne naturel Asteiche furniert	 RG Placcato rovere grigio Grey oak veneer Placage chêne gris Eiche grau furniert	 RA Placcato rovere antracite Anthracite oak veneer Placage chêne anthracite Eiche anthrazit furniert
--	--	--

## CERAMICA / CERAMIC / CÉRAMIQUE / KERAMIK

 NS Placcato noce scuro Dark walnut veneer Placage noyer foncé Nussbaum furniert	 CCE Ceramica effetto cemento Ceramic cement effect Céramique effet beton Keramik - (Optik: Zement)	 CPA Ceramica effetto pietra antracite Ceramic anthracite stone effect Céramique effet pierre anthracite Keramik (Effekt-Stein anthrazit)
---	--	--

## DESIGN LINE / DESIGN-LINE

Finiture per DESIGN LINE e base  
DESIGN LINE and socle finishes  
Finitions pour Design line et base  
Design-Line und Sockelumrandung

 LRS DESIGN LINE rame spazzolato DESIGN LINE: brushed copper DESIGN LINE cuivre brossé Design-Line Kupfer gebürstet	 LAS DESIGN LINE acciaio spazzolato DESIGN LINE: brushed steel DESIGN LINE acier brossé Design-Line Stahl gebürstet	 LNO DESIGN LINE nero opaco DESIGN LINE: matt black DESIGN LINE noir mat Design-Line schwarz matt
--	--	--

## PIEDINI / FEET / PIEDS / KUFENFÜSSE

Finiture per piedini opzionali  
Finishes for optional feet  
Finitions pour pieds optionnels  
Materialausführungen für  
die optionalen Kufenfüße

 LRS Rame spazzolato Brushed copper Cuivre brossé Kupfer gebürstet	 LAS Acciaio spazzolato Brushed steel Acier brossé Stahl gebürstet	 LNO Acciaio spazzolato Brushed steel Acier brossé Stahl gebürstet
---	---	---

# MO&MA DETAILS



Vetro temperato  
Tempered glass  
Verre trempé  
Temperiertes Glas



Vetro laccato che consente l'input del telecomando  
Remote friendly lacquered glass door  
Verre laqué permettant l'input de la télécommande  
Infrarotdurchlässige Glas- Frontklappe



Illuminazione LED  
LED lighting  
Eclairage LED  
LED-Rückwandbeleuchtung



Multipresa 6 ingressi inclusa  
6 Way Multi plug included  
Multiprise 6 entrées incluse  
Mehrfach-Steckdose mit 6 Eingängen

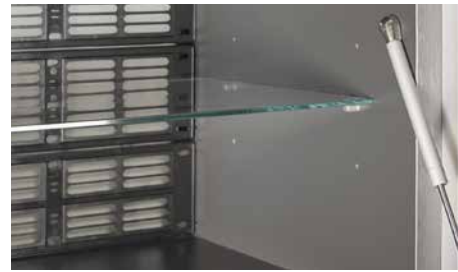

Mensole in vetro regolabili  
Adjustable glass shelves  
Étagères réglables en verre  
Verstellbare Glas-Einlegeböden



Interruttore touch e regolatore di intensità della luce  
Touch switch and light intensity controller  
Interrupteur tactile et contrôleur d'intensité lumineuse  
Beleuchteter Touchdimmer für LED-Beleuchtungen



Apertura a ribalta munita di freno  
Shock resistant pull down door  
Volet abattant muni de frein  
Frontklappe mit Soft-Close-Beschlag

## OPTIONAL

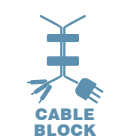

Organizzazione intelligente dei cavi  
Smart cable management  
Organisation intelligente des câbles  
Geordnete und versteckte Kabelführung



Ruote pivotanti nascoste  
Concealed castors  
Roulettes pivotantes cachées  
Versteckte Rollen in Sockelplatte



Piedini  
Feet  
Pieds  
Kufenfüße



Griglia removibile per raffreddamento dei componenti elettronici  
Detachable and ventilated grills for air circulation  
Grille amovible pour le refroidissement des composants électroniques  
Abnehmbares Rückwand-Belüftungsgitter für einfachen Kabelzugang und zur Kühlung der elektronischen Geräte

# MO&MA DETAILS

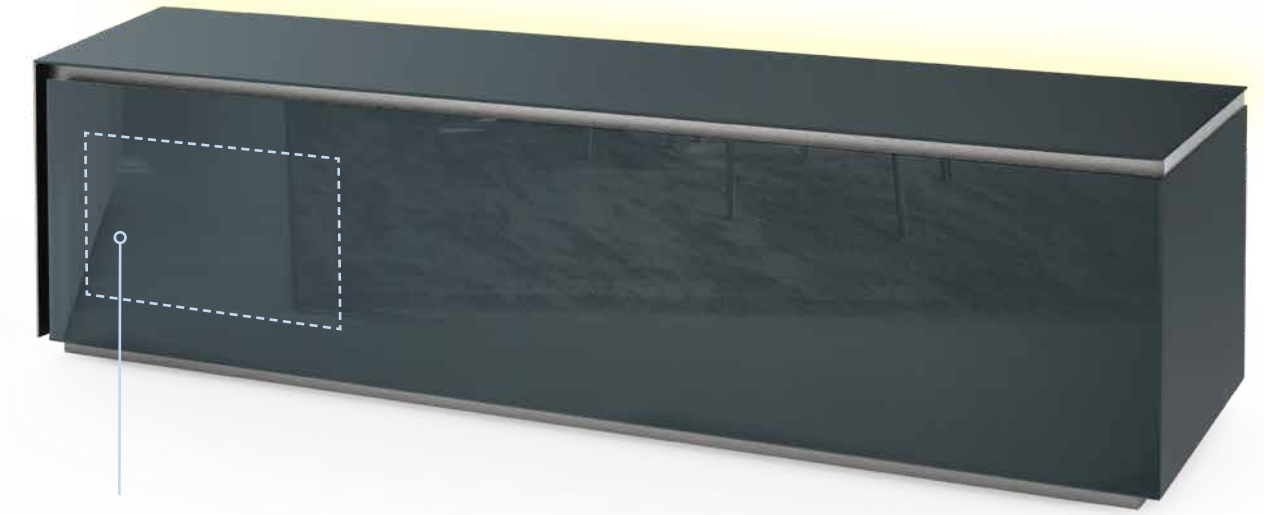

Vetro laccato che consente l'input del telecomando  
Remote friendly lacquered glass door  
Verre laqué permettant l'input de la télécommande  
Infrarotdurchlässige Glas- Frontklappe

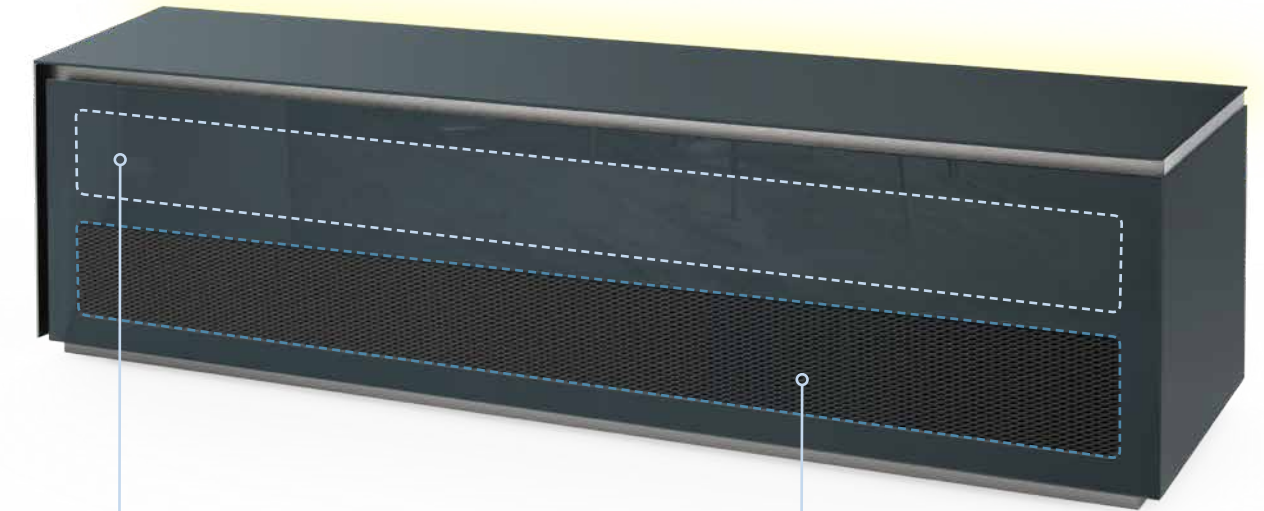

Vetro laccato che consente l'input del telecomando  
Remote friendly lacquered glass door  
Verre laqué permettant l'input de la télécommande  
Infrarotdurchlässige Glas- Frontklappe



Pannello metallico forato per Sound System che consente anche l'input del telecomando  
Remote friendly metallic mesh for Sound System  
Treillis métallique pour la barre de son et aussi pour l'input de la télécommande  
Sounddurchlässiges lackiertes Metall-Gitter

## OPTIONAL SOUND SYSTEM ACS 120 W





MMB 174 L - NE CPA LAS  
 OPTIONAL: VR 117 NE NE + MO 352 NEM CPA

# MO&MA GROUND H. 42

Mobili TV a pavimento con anta a ribalta in vetro con "Active Door"  
 Floor TV cabinets with pull down glass "Active Door"  
 Meubles posés au sol avec volet abattant en verre Active door  
 TV-Elemente mit infrarotdurchlässiger Glasfrontklappe

MMB 125 L

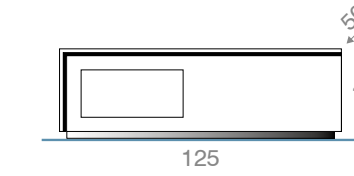

MMB 125 R

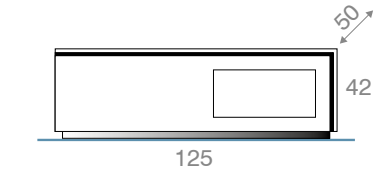

MAX TV DIMENSIONS  
 Fino a / Up to 55" (140cm)

MMB 150 L

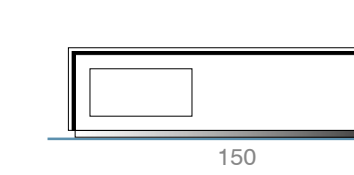

MMB 150 R

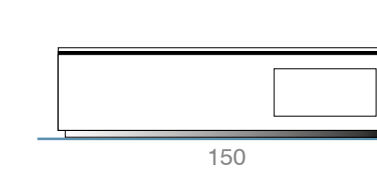

MAX TV DIMENSIONS  
 Fino a / Up to 65" (165cm)

MMB 174 L

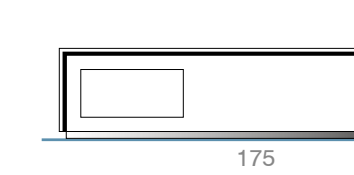

MMB 174 R

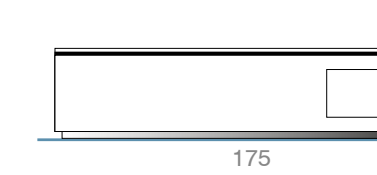

MAX TV DIMENSIONS  
 Fino a / Up to 75" (190cm)

Mobili TV a pavimento in vetro temperato con due ante a ribalta di cui una con "Active Door"  
 Floor TV cabinets with pull down "Active Door" and another pull down door without "Active Door"  
 Meuble posés au sol avec 1 volet abattant en verre Active door et 1 volet abattant sans Active door  
 TV-Unterteile mit einer infrarotdurchlässigen- und einer geschlossenen Glas-Frontklappe

MMB 200 L

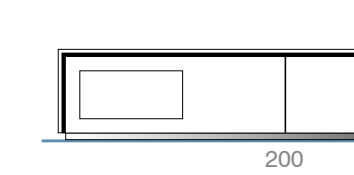

MMB 200 R

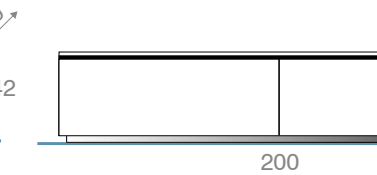

MAX TV DIMENSIONS  
 Fino a / Up to 85" (216cm)



MMB 150 R - GS GS LAS



MMB 200 L - BI CCE LNO



Vetro laccato che consente l'input del telecomando  
 Remote friendly lacquered glass door  
 Verre laqué permettant l'input de la télécommande  
 Infrarotdurchlässige Glas- Frontklappe





MMB 202 L - NE NE LRS  
OPTIONAL: VR 123 NE NE + MO 351 NEM SP

# MO&MA GROUND H. 51

Mobili TV a pavimento con anta a ribalta in vetro con "Active Door"  
Floor TV cabinets with pull down glass "Active Door"  
Meubles posés au sol avec volet abattant en verre Active door  
TV-Elemente mit infrarotdurchlässiger Glasfrontklappe

MMB 126 L

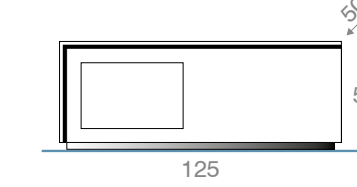

MMB 126 R

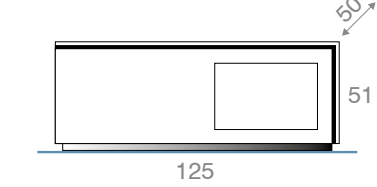

MMB 152 L

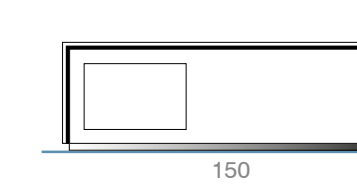

MMB 152 R

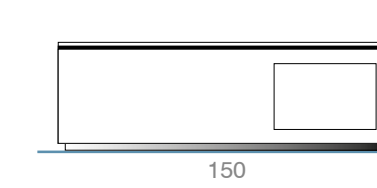

MMB 176 L

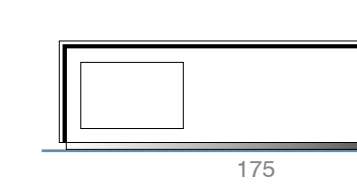

MMB 176 R

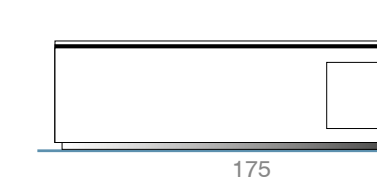

**MAX TV DIMENSIONS**  
Fino a / Up to 55" (140cm)



**MAX TV DIMENSIONS**  
Fino a / Up to 65" (165cm)



**MAX TV DIMENSIONS**  
Fino a / Up to 75" (190cm)

Mobili TV a pavimento con anta a ribalta in vetro. "Active Door" sulla sinistra e cassetto sulla destra  
Floor TV cabinets with pull down glass "Active Door" on the left side and drawer on the right  
Meubles posés au sol avec volet abattant en verre. Active door à gauche et tiroir à droite  
TV-Unterteile mit infrarotdurchlässiger Frontklappe auf der linken und Schublade auf der rechten Seite

MMB 202 L

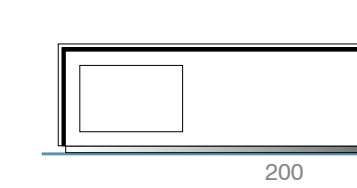

MMB 202 R

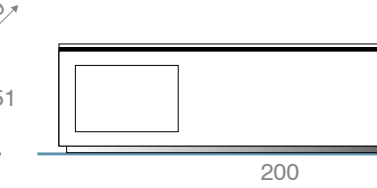

**MAX TV DIMENSIONS**  
Fino a / Up to 85" (216cm)



MMB 152 R - BI BI LNO

PERFECT  
FORM,  
CLEVER  
FUNCTION



**ACTIVE DOOR™**  
Vetro laccato che consente l'input del telecomando  
Remote friendly lacquered glass door  
Verre laqué permettant l'input de la télécommande  
Infrarotdurchlässige Glas- Frontklappe



**SOFT MOTION DRAWER**  
Cassetto munito di freno  
Soft motion drawer  
Tiroir avec frein  
Schublade mit Soft-Close-Beschlag



MMB 175 L - BI CCE LNO

# MO&MA GROUND SOUND

Mobili a pavimento con anta a ribalta in vetro "Active Door" e pannello metallico forato per sound  
 Floor cabinets with pull down glass "Active Door" and metallic mesh for sound  
 Meubles posés au sol avec volet abattant en verre. Active door et treillis métallique pour le son  
 TV-Unterteile mit infrarot- und sounddurchlässiger Glasfrontklappe

MMB 175 L

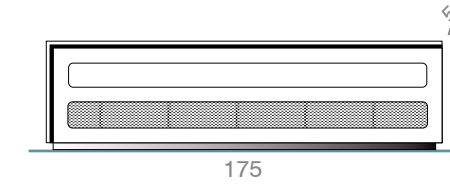

MMB 175 R

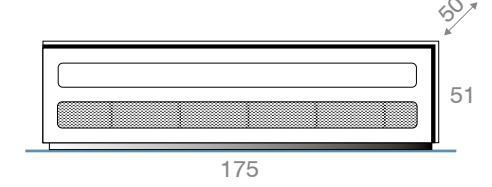

**MAX TV DIMENSIONS**  
 Fino a / Up to 75" (190cm)

Mobili a pavimento con anta a ribalta in vetro. "Active Door" e pannello metallico forato per sound. Cassetto sulla destra  
 Floor cabinets with pull down glass "Active Door" and metallic mesh for sound. Drawer on the right  
 Meubles posés au sol avec volet abattant en verre. Active door et treillis métallique pour le son. Tiroir à droit  
 TV-Elemente mit infrarot- und sounddurchlässiger Glasfrontklappe auf der linken und Schublade auf der rechten Seite

MMB 201 L

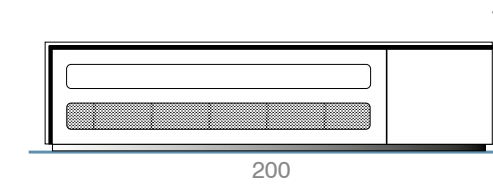

MMB 201 R

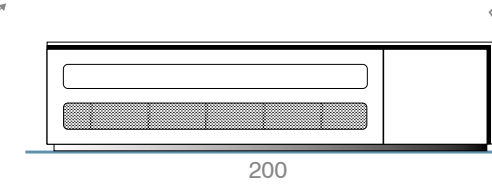

**MAX TV DIMENSIONS**  
 Fino a / Up to 85" (216cm)



MMB 201 L - NE NS LAS



**ACTIVE DOOR™**  
 Vetro laccato che consente l'input del telecomando  
 Remote friendly lacquered glass door  
 Verre laqué permettant l'input de la télécommande  
 Infrarotdurchlässige Glas- Frontklappe

**SOUND**  
 Pannello metallico forato per Sound System  
 che consente anche l'input del telecomando  
 Remote friendly metallic mesh for Sound System  
 Treillis métallique pour la barre de son  
 et aussi pour l'input de la télécommande  
 Sounddurchlässiges lackiertes Metall-Gitter

**SOFT MOTION DRAWER**  
 Cassetto munito di freno  
 Soft motion drawer  
 Tiroir avec frein  
 Schublade mit Soft-Close-Beschlag



LIVING MO&MA BI RG LNO

## MO&MA DESIGN FEET

Mobili a pavimento con piedini opzionali  
 Floor cabinets with optional feet  
 Meubles posés au sol avec pieds optionnels  
 TV-Grundelemente mit optionalen Kufenfüßen

Lunghezza mobile e codice piedini  
 Cabinet length and feet code  
 Longueur du meuble et codes pieds  
 Bestellnummern und Breitenangaben der optionalen Kufenfüße

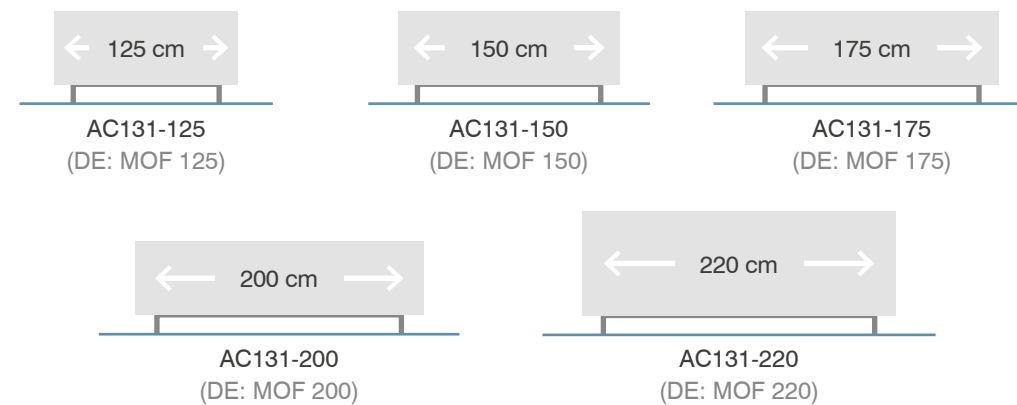
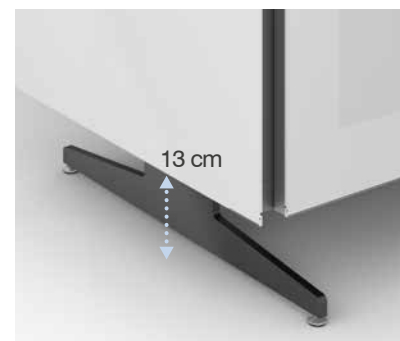
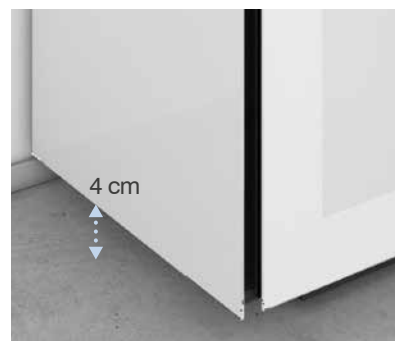

MMB 202 R - NE NE LAS  
 OPTIONAL: AC131-200 (DE: MOF 200) LAS

# SOUND SYSTEM ACS 120 W

**CARBON LOOK**  
 Finitura carbonio  
 Carbon look finish  
 Finition carbone  
 Karbon-Frontblende



**Doppio subwoofer**  
 Double subwoofer  
 Double subwoofer  
 Doppelter Subwoofer



**Ingressi di collegamento**  
 Connection inputs  
 Entrées de connexion  
 Anschlüsse-Eingänge



**Casse acustiche di qualità**  
 High-end loudspeakers  
 Haut-parleurs de qualité  
 Hochwertige Lautsprecher



**Display digitale**  
 Digital display  
 Display digital  
 Digital display

ACS 120 W L.95 H.18 P.30

**Potenza: 120W RMS**  
**Ingressi: Hdmi, Bluetooth, Coaxial, Aux TV, Optical**  
**Modalità di equalizzazione: pop, rock, disco, classic**  
**Alimentazione: 110/220/240 Volt**  
**Telecomando incluso**

**Power: 120W RMS**  
**Input: Hdmi, Bluetooth, Coaxial, Aux TV, Optical**  
**Equalisation modes: pop, rock, disco, classic**  
**Power source: 110/220/240 Volt**  
**Remote control included**

**Puissance: 120W RMS**  
**Entrée: Hdmi, Bluetooth, Coaxial, Aux TV, Optique**  
**Modalités d'egalisation: pop, rock, disco, classic**  
**Source d'alimentation: 110/220/240 Volt**  
**Télécommande incluse**

**Leistung: 120W RMS**  
**Eingänge: Hdmi, Bluetooth, Coaxial, Aux TV, Optical**  
**Equalizer-Modi: pop, rock, disco, classic**  
**Stromversorgung: 110/220/240 Volt**  
**Incl. Fernbedienung**



# MO&MA TV SUPPORT

## TV Support: MI 310+SP 062

**Colonna in acciaio inox orientabile e regolabile in altezza**  
 Revolving and height adjustable pillar for TV in stainless steel  
 Colonne orientable et réglable en hauteur en acier inoxydable  
 Höhenverstellbare TV-Säule aus Stahl gebürstet mit drehbarer Funktion



**SP 062 abbinata a MI 310 per VESA 800x400**  
 SP 062 combined with MI 310 for VESA 800x400  
 SP 062 combiné avec MI 310 pour VESA 800x400  
 SP 062 in Kombination mit MI 310 für VESA 800x400

**MAX TV DIMENSIONS**  
 fino a / Up to  
 75" (190 cm)

**MAXIMUM TV WEIGHT**  
 max 50

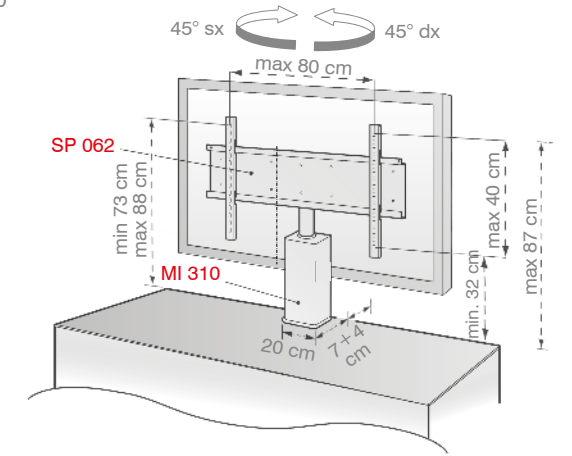

## TV Support: AC 376

**Colonna tonda orientabile in finitura silver o antracite regolabile in altezza**  
 Revolving and height adjustable round pillar for TV in silver or anthracite finish  
 Colonne ronde orientable et réglable en hauteur avec finition silver ou anthracite  
 Runde TV-Säule mit drehbarer Funktion und höhenverstellbaren TV-Halterungen  
 in Ausführungen silver satiniert oder anthrazit pulverbeschichtet

AC 376 SI

AC 376 AN



**MAX TV DIMENSIONS**  
 fino a / Up to  
 65" (165 cm)

**MAXIMUM TV WEIGHT**  
 max 45

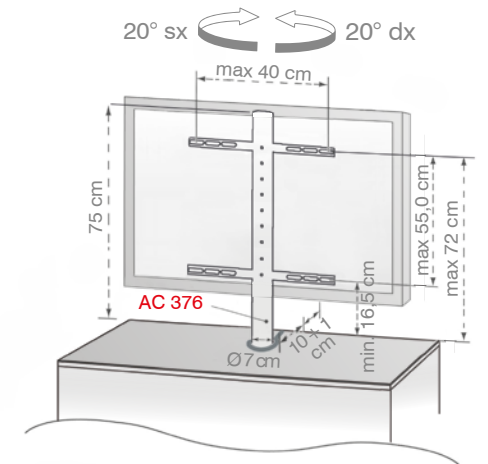

## TV Support: AC 380 AN

**Colonna TV orientabile, inclinabile e regolabile in altezza. Finitura antracite**  
 Revolving, tiltable and height adjustable TV pillar. Anthracite finish  
 Colonne TV orientable, inclinable, réglable en hauteur en finition anthracite  
 Dreh-, schwenk- und höhenverstellbare TV-Säule anthrazit lackiert



**MAX TV DIMENSIONS**  
 fino a / Up to  
 75" (190 cm)

**MAXIMUM TV WEIGHT**  
 max 50

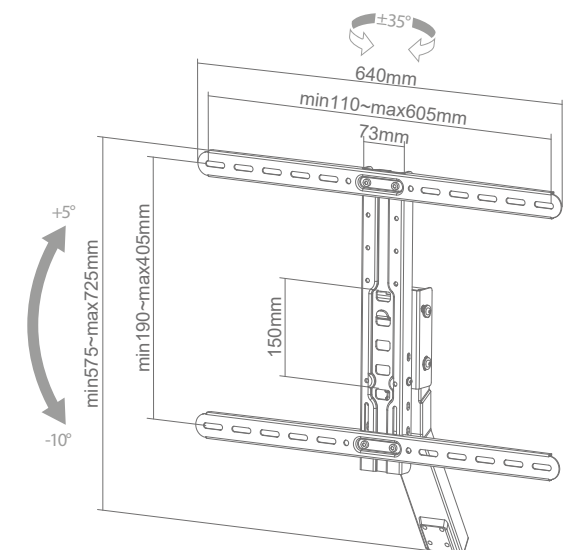



MMW 176 L - GS RN LNO  
OPTIONAL: VR 123 GS GS + MO 351 NEM RN



MMW 200 R - BI CCE LNO  
OPTIONAL: VR 117 BI BI + MO 352 NEM CCE



# MO&MA WALL

Mobile TV sospeso in vetro temperato con anta a ribalta "Active Door"  
Suspended tempered glass TV cabinet with pull down "Active Door"  
Meubles suspendus avec volet abattant en verre Active door  
TV-Hängeelement mit infrarotdurchlässiger Glasfrontklappe

MMW 150 L

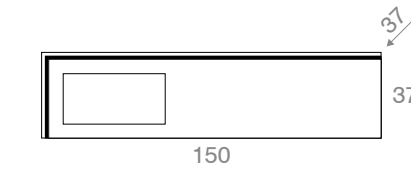

MMW 150 R

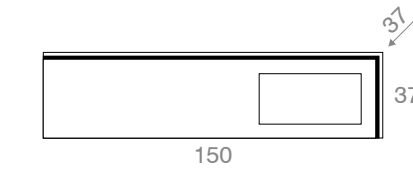

**MAX TV DIMENSIONS**  
Fino a / Up to 65" (165cm)

MMW 176 L

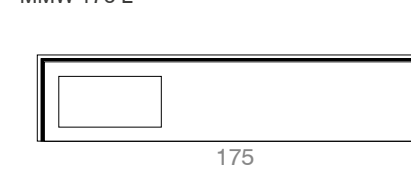

MMW 176 R

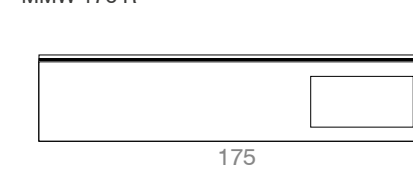

**MAX TV DIMENSIONS**  
Fino a / Up to 75" (190cm)

Mobile TV sospeso in vetro temperato con due ante a ribalta di cui una con "Active Door"  
Suspended tempered glass TV wall cabinet with pull down "Active Door" and another pull down door without "Active Door"  
Meuble suspendus avec 1 volet abattant en verre Active door et 1 volet abattant sans Active door  
TV-Hängeelement mit einer infrarotdurchlässigen- und einer geschlossenen Glas-Frontklappe

MMW 200 L

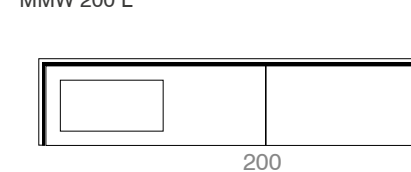

MMW 200 R

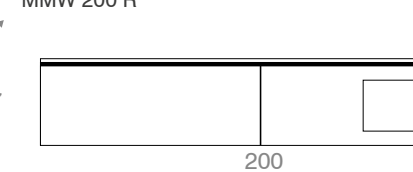

**MAX TV DIMENSIONS**  
Fino a / Up to 85" (216cm)

**ACTIVE DOOR™**  
Vetro laccato che consente l'input del telecomando  
Remote friendly lacquered glass door  
Verre laqué permettant l'input de la télécommande  
Infrarotdurchlässige Glas-Frontklappe

**FMS**  
Mobile estraibile per facilitare il passaggio dei cavi  
The unit can slide out onto strong supports for a smart cable management

**FOLLOW ME SYSTEM**  
Meuble coulissant pour faciliter le passage des câbles

Neuartiger Hängebeschlag für einfaches und flexibles Kabelmanagement

# FOLLOW ME SYSTEM



Mobile estraibile per facilitare il passaggio dei cavi

The unit can slide out onto strong supports for a smart cable management

Meuble coulissant pour faciliter le passage des câbles

Neuartiger Hängebeslag für einfaches und flexibles Kabelmanagement

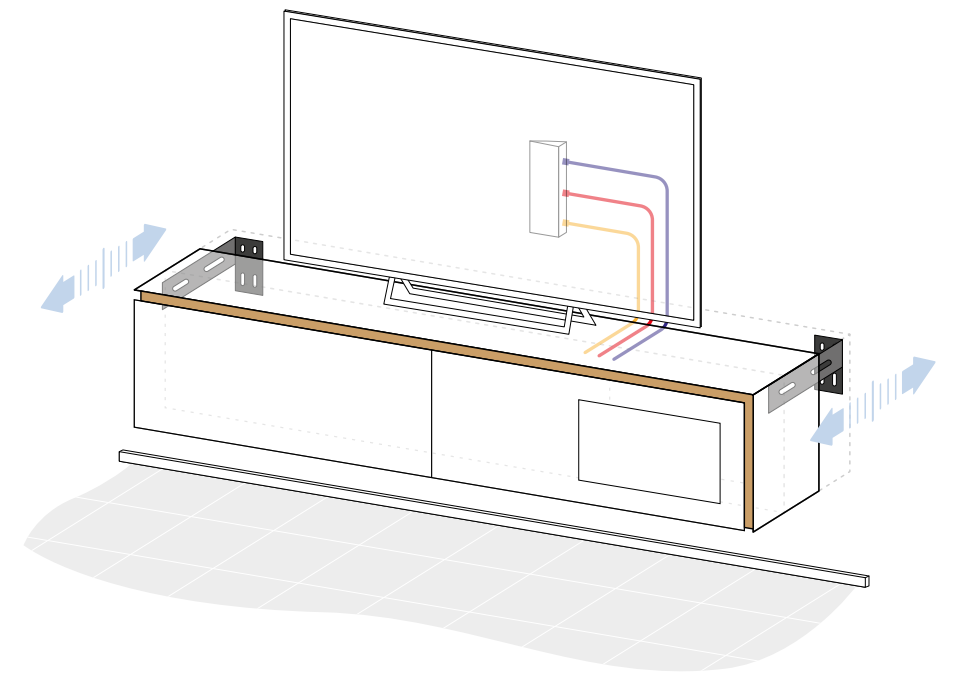

Organizzazione intelligente dei cavi  
Smart cable management  
Organisation intelligente des câbles  
Geordnete und versteckte Kabelführung



Multipresa 6 ingressi inclusa  
6 Way Multi plug included  
Multiprise 6 entrées incluse  
Mehrfach-Steckdose mit 6 Eingängen



Griglia removibile per raffreddamento dei componenti elettronici  
Detachable and ventilated grills for air circulation  
Grille amovible pour le refroidissement des composants électroniques  
Abnehmbares Rückwand-Belüftungsgitter für einfachen Kabelzugang und zur Kühlung der elektronischen Geräte





MMS 220 L - NE NE LRS

# MO&MA SIDEBOARD

Madia con 4 ante soft motion  
 Sideboard with 4 soft motion doors  
 Buffet avec 4 portes munies de frein  
 Bodenstehendes Sideboard mit 4 temperierten Push-Pull Glas-Drehtüren

MMS 220 L

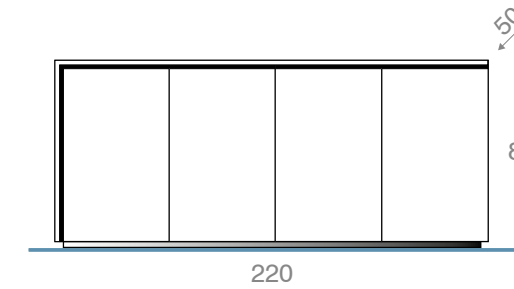

MMS 220 R

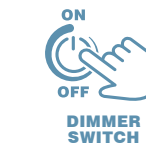
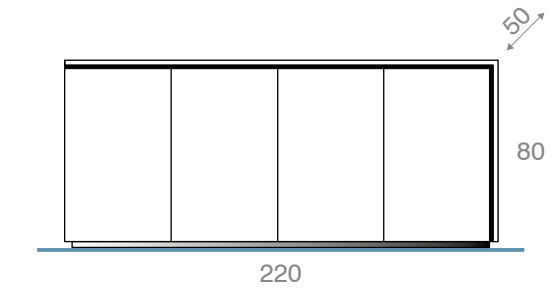

Interruttore touch e regolatore di intensità della luce  
 Touch switch and light intensity controller  
 Interrupteur tactile et contrôleur d'intensité lumineuse  
 Beleuchteter Touchdimmer für LED-Beleuchtungen



Illuminazione LED  
 LED lighting  
 Eclairage LED  
 LED-Rückwandbeleuchtung



Chiusura ante soft-motion  
 Soft-motion closing  
 Fermeture des portes avec frein  
 Soft-Motion Beschlag



Mobili rivestiti in vetro temperato  
 Units layered with tempered glass  
 Meubles recouvertes de verre trempé  
 Fronten aus temperiertem Glas



Piedini  
 Feet  
 Pieds  
 Kufenfüße



AC131-220  
 (DE: MOF 220)



MMSW 200 L - GS RN LAS

# MO&MA WALL SIDEBOARD

**Madia sospesa con 4 ante soft motion**  
 Suspended wall sideboard with 4 soft motion doors  
 Buffet horizontal suspendu avec 4 portes munies de frein  
 Wandhängendes Sideboard mit 4 temperierten Push-Pull Glas-Drehtüren

MMSW 200 L

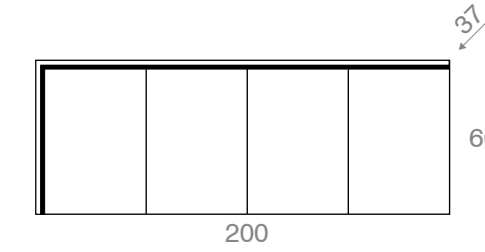

MMSW 200 R

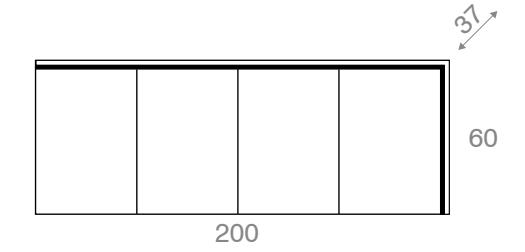



# MO&MA CLOSED COFFEE TABLE

Tavolino con 2 ante a ribalta e 1 mensola interna  
 Coffee table with 2 pull down doors and 1 internal shelf  
 Table basse avec 2 volets abattants et 1 étagère interne  
 Couchtisch mit 2 gegenüberliegenden Frontklappen und 1 Innen-Glasboden



Vista lato sinistro  
 View left side  
 Vue côté gauche  
 Linksansicht



Vista lato destro  
 View right side  
 Vue côté droit  
 Rechtsansicht

# VERONA OPEN COFFEE TABLE

Tavolino con struttura in metallo, vani a giorno su 2 lati  
 Coffee table with metal structure and 2 open compartments on 2 sides  
 Table basse avec structure métallique et 2 compartiments ouverts sur 2 côtés  
 Couchtisch mit Metall-Korpus und 2 gegenüberliegenden offenen Fächern mit Glasböden

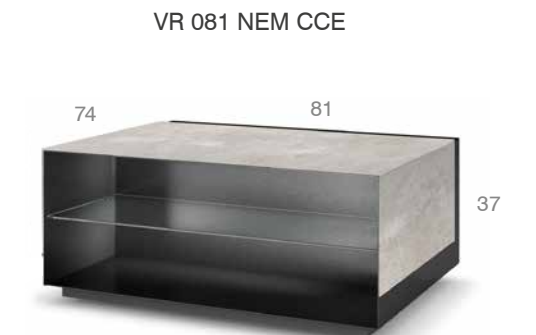

Vista lato sinistro  
 View left side  
 Vue côté gauche  
 Linksansicht



Vista lato destro  
 View right side  
 Vue côté droit  
 Rechtsansicht

81 combinazioni di finiture  
 81 finishing combinations  
 81 combinaisons de finitions  
 81 Farb- und Materialkombinationen



...BI BI LNO



...GS GS LAS



...NE NE LRS



...NEM BI



...NEM GS



...NEM NE



...BI NS LNO



...GS RA LAS



...NE CPA LRS



...NEM RN



...NEM CPA



...NEM RA

# TECHNICAL DETAILS



## MO&MA GROUND H. 42

Mobili TV a pavimento con anta a ribalta in vetro con "Active Door"  
 Floor TV cabinets with pull down glass "Active Door"  
 Meubles posés au sol avec volet abattant en verre Active door  
 TV-Elemente mit infrarotdurchlässiger Glasfrontklappe

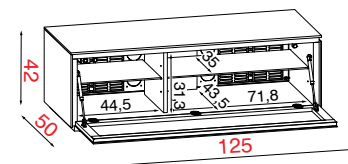
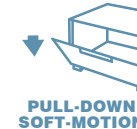

MMB 125...



MAX TV DIMENSIONS

fino a / Up to 55"(140 cm)



MAXIMUM TV WEIGHT

max 70

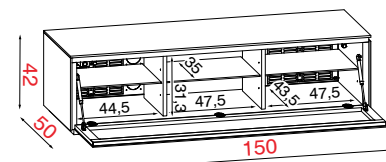

MMB 150...



MAX TV DIMENSIONS

fino a / Up to 65"(165 cm)



MAXIMUM TV WEIGHT

max 70

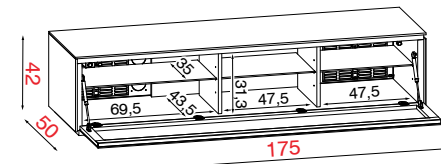

MMB 174...



MAX TV DIMENSIONS

fino a / Up to 75"(190 cm)



MAXIMUM TV WEIGHT

max 70

Mobili TV a pavimento in vetro temperato con due ante a ribalta di cui una con "Active Door"  
 Floor TV cabinets with pull down "Active Door" and another pull down door without "Active Door"  
 Meuble posés au sol avec 1 volet abattant en verre Active door et 1 volet abattant sans Active door  
 TV-Unterteile mit einer infrarotdurchlässigen- und einer geschlossenen Glas-Frontklappe

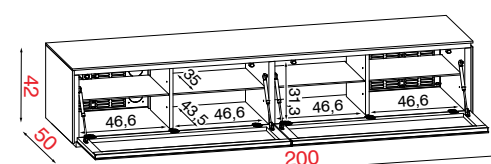
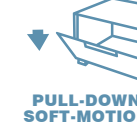

MMB 200...



MAX TV DIMENSIONS

fino a / Up to 85"(216 cm)



MAXIMUM TV WEIGHT

max 100



## MO&MA GROUND H. 51

Mobili TV a pavimento con anta a ribalta in vetro con "Active Door"  
 Floor TV cabinets with pull down glass "Active Door"  
 Meubles posés au sol avec volet abattant en verre Active door  
 TV-Elemente mit infrarotdurchlässiger Glasfrontklappe

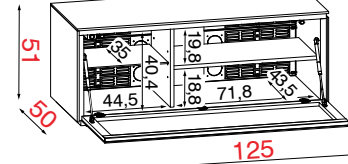
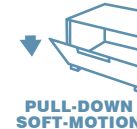

MMB 126...



MAX TV DIMENSIONS

fino a / Up to 55"(140 cm)



MAXIMUM TV WEIGHT

max 70

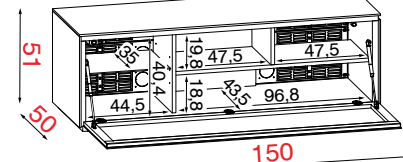

MMB 152...



MAX TV DIMENSIONS

fino a / Up to 65"(165 cm)



MAXIMUM TV WEIGHT

max 70

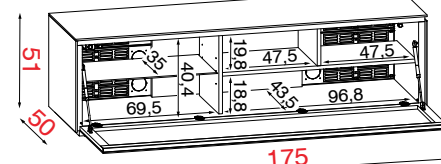

MMB 176...



MAX TV DIMENSIONS

fino a / Up to 75"(190 cm)



MAXIMUM TV WEIGHT

max 70

Mobili TV a pavimento con anta a ribalta in vetro. "Active Door" sulla sinistra e cassetto sulla destra  
 Floor TV cabinets with pull down glass "Active Door" on the left side and drawer on the right  
 Meubles posés au sol avec volet abattant en verre. Active door à gauche et tiroir à droite  
 TV-Unterteile mit infrarotdurchlässiger Frontklappe auf der linken und Schublade auf der rechten Seite

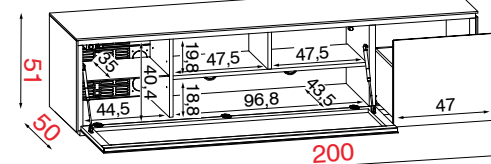
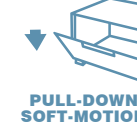

MMB 202...



MAX TV DIMENSIONS

fino a / Up to 85"(216 cm)



MAXIMUM TV WEIGHT

max 100



## MO&MA GROUND SOUND

Mobili a pavimento con anta a ribalta in vetro. "Active Door" e pannello metallico forato per sound  
 Floor cabinets with pull down glass "Active Door" and metallic mesh for sound  
 Meubles posés au sol avec volet abattant en verre. Active door et treillis métallique pour le son  
 TV-Unterteile mit infrarot- und sounddurchlässiger Glasfrontklappe

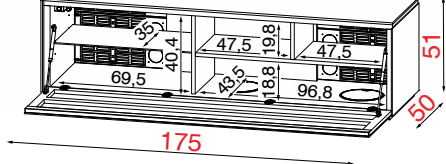
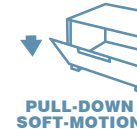

MMB 175...



MAX TV DIMENSIONS

fino a / Up to 75"(190 cm)



MAXIMUM TV WEIGHT

max 70

Mobili a pavimento con anta a ribalta in vetro. "Active Door" e pannello metallico forato per sound. Cassetto sulla destra  
 Floor cabinets with pull down glass "Active Door" and metallic mesh for sound. Drawer on the right  
 Meubles posés au sol avec volet abattant en verre. Active door et treillis métallique pour le son. Tiroir à droite  
 TV-Elemente mit infrarot- und sounddurchlässiger Glasfrontklappe auf der linken und Schublade auf der rechten Seite

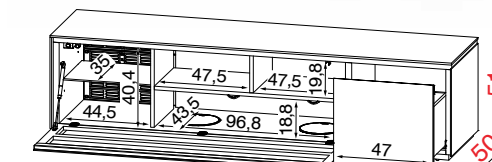
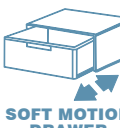
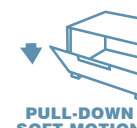

MMB 201...



MAX TV DIMENSIONS

fino a / Up to 85"(216 cm)



MAXIMUM TV WEIGHT

max 100

### OPTIONAL SOUND SYSTEM ACS 120 W



## MO&MA FEET - OPTIONAL

Mobili a pavimento con piedini opzionali  
 Floor cabinets with optional feet  
 Meubles posés au sol avec pieds optionnels  
 TV-Grundelemente mit optionalen Kufenfüßen

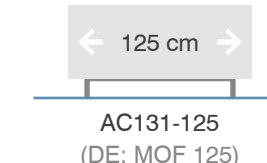

AC131-125 (DE: MOF 125)

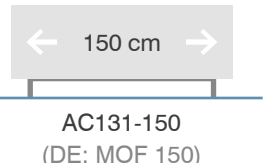

AC131-150 (DE: MOF 150)



AC131-175 (DE: MOF 175)



AC131-200 (DE: MOF 200)

## MO&MA TV SUPPORT

Supporti TV / TV support / TV Supports / TV-Säule



TV SUPPORT: MI 310+SP 062



MAX TV DIMENSIONS

fino a / Up to 75"(190 cm)



MAXIMUM TV WEIGHT

max 50

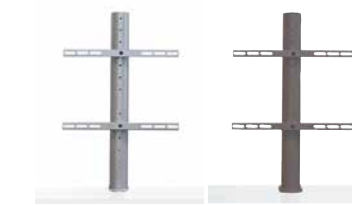

TV SUPPORT: AC 376



MAX TV DIMENSIONS

fino a / Up to 65"(165 cm)



MAXIMUM TV WEIGHT

max 45



TV SUPPORT: AC 380 AN



MAX TV DIMENSIONS

fino a / Up to 75"(190 cm)



MAXIMUM TV WEIGHT

max 50



# TECHNICAL DETAILS

## MO&MA WALL

Mobile TV speso in vetro temperato con anta a ribalta "Active Door"  
Suspended tempered glass TV wall cabinet with pull down "Active Door"  
Meubles suspendus avec volet abattant en verre Active door  
TV-Hängeelement mit infrarotdurchlässiger Glasfrontklappe

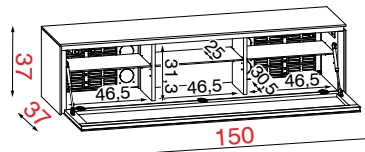
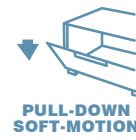
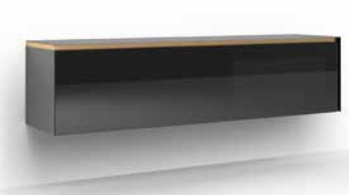

MMW 150...



fino a / Up to 65" (165 cm)



max 40

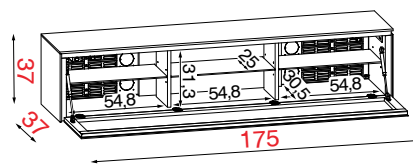

MMW 176...



fino a / Up to 75" (190 cm)



max 40

Mobile TV sospeso in vetro temperato con un'anta a ribalta con "Active Door" e un'anta a ribalta senza "Active Door"  
Suspended tempered glass TV wall cabinet with pull down "Active Door" and 1 pull down door without "Active Door"  
Meuble suspendus avec 1 volet abattant en verre Active door et 1 volet abattant sans Active door  
TV-Hängeelement mit einer infrarotdurchlässigen- und einer geschlossenen Glas-Frontklappe

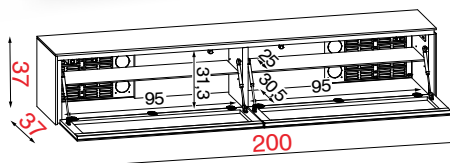
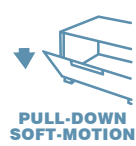

MMW 200...



fino a / Up to 85" (216 cm)



max 50

## WALL CABLE ORGANIZER

Copricavi / Wall cable organizer / Gaine pour câbles / Wand-Kabelkanäle



SP 918 BI L.18,6 H.18 P.2,5



SP 933 BI L.18,6 H.33 P.2,5



FRONT FINISHING

## MO&MA SIDEBORD

Madia con 4 ante soft motion  
Sideboard with 4 soft motion doors  
Buffet avec 4 portes munies de frein  
Bodenstehendes Sideboard mit 4 temperierten Push-Pull Glas-Drehtüren

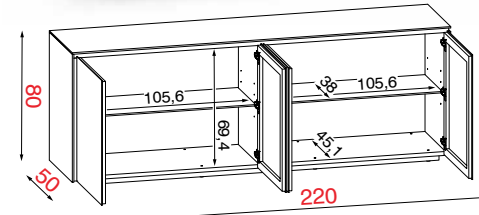

MMS 220...

## MO&MA FEET - OPTIONAL

Madia con 4 ante soft motion e piedini opzionali  
Sideboard with 4 soft motion doors and optional feet  
Buffet avec 4 portes munies de frein et pieds optionnels  
Bodenstehendes Sideboard mit 4 temperierten Push-Pull Glas-Drehtüren und optionalen Kufenfüßen



AC131-220 (DE: MOF 220)

## MO&MA WALL SIDEBORD

Madia sospesa con 4 ante soft motion  
Suspended wall sideboard with 4 soft motion doors  
Buffet horizontal suspendu avec 4 portes munies de frein  
Wandhängendes Sideboard mit 4 temperierten Push-Pull Glas-Drehtüren

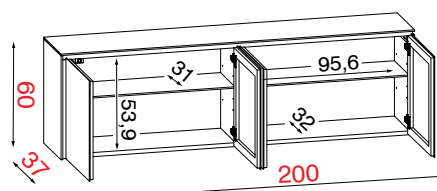

MMSW 200...

# TECHNICAL DETAILS

## MO&MA CLOSED COFFEE TABLE

Tavolino con 2 ante a ribalta e 1 mensola interna  
Coffee table with 2 pull down doors and 1 internal shelf  
Table basse avec 2 volets abattants et 1 étagère interne  
Couchtisch mit 2 gegenüberliegenden Frontklappen und 1 Innen-Glasboden

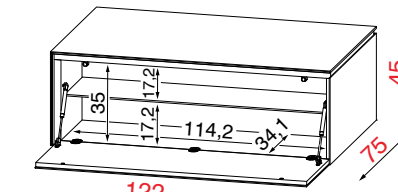

MMT 120...



## HANGING ELEMENTS

Pensile in vetro temperato. Disponibile il frontale in legno  
Glass tempered wall element, wooden frontal also available  
Elément suspendu verre trempé ou façade en bois  
Hängeschränke mit temperierten Glas- oder furnierten Holz-Drehtüren, rechts oder links angeschlagen (Ausführungen siehe Preisliste)



VR 117 SX-L

Interno antracite  
Anthracite color inside  
Interieur anthracite  
Innenkorpus-Ausführung: anthrazit

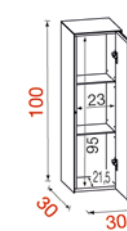

VR 117 DX-R



VR 123 SX-L

Interno antracite  
Anthracite color inside  
Interieur anthracite  
Innenkorpus-Ausführung: anthrazit

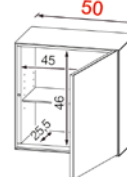

VR 123 DX-R

## VERONA OPEN COFFEE TABLE

Tavolino con struttura in metallo, 2 vani a giorno aperti su 2 lati  
Coffee table with metal structure and 2 open compartments on 2 sides  
Table basse avec structure métallique et 2 compartiments ouverts sur 2 côtés  
Couchtisch mit Metall-Korpus und 2 gegenüberliegenden offenen Fächern mit Glasböden

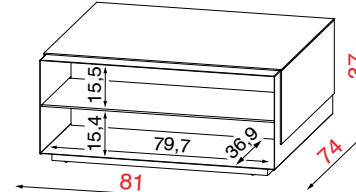

VR 081...

## OPEN HANGING ELEMENTS

Pensili a giorno in metallo con schiena in legno, ceramica o a specchio  
Open wall metal elements with mirror, wooden or ceramic back wall  
Elément suspendu métallique ouvert avec le dos en miroir, bois plaqué ou céramique  
Offene Hängeregale mit wahlweise verspiegelter, Echtholz furnierter oder Keramik Rückwand (Ausführungen siehe Preisliste)



MO 351 NEM

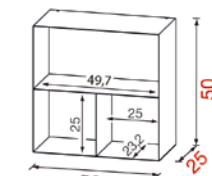

MO 352 NEM

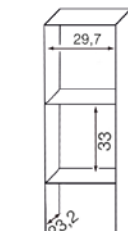

## LED-OLED WALL BRACKETS

Supporti a muro / Wall TV brackets / Supports muraux / TV-Wandhalterungen



SP 361 MAX VESA 400X400



fino a / Up to 60" (152 cm)



max 40



SP 362 MAX VESA 600X400



fino a / Up to 65" (155 cm)



max 40



SP 754 MAX VESA 600X400



fino a / Up to 80" (203 cm)



max 60





create your home

**MUNARI S.r.l.**

37050 Ca' degli Oppi di Oppeano (Verona) Italy

Ph. +39 045 7130145/190

[www.munari.it](http://www.munari.it)

e-mail: [munari@munari.it](mailto:munari@munari.it)

